

FEATURES

- **BROAD BAND INTERNALLY MATCHED HEMT**
- **HIGH POWER**
Pout= 44.0dBm at Pin= 39.0dBm
- **HIGH GAIN**
GL= 8.0dB at 12.7GHz to 13.2GHz
- **LOW INTERMODULATION DISTORTION WITH WIDE SPACING TONE**
IM3(Min.)= -25dBc at Pout= 37.0dBm (Single Carrier Level)
- **HERMETICALLY SEALED PACKAGE**

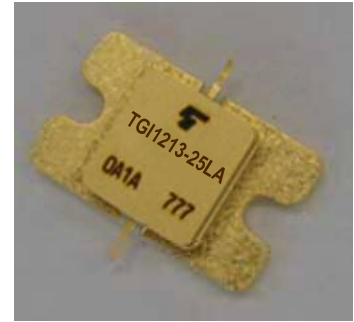

RF PERFORMANCE SPECIFICATIONS (Ta= 25°C)

CHARACTERISTICS	SYMBOL	CONDITIONS	UNIT	MIN.	TYP.	MAX.
Output Power	Pout	VDS= 24V IDSset= 1.0A f = 12.7 to 13.2GHz @Pin= 39dBm	dBm	43.0	44.0	—
Drain Current	IDS1		A	—	2.5	3.0
Power Added Efficiency	PAE		%	—	29	—
Linear Gain	GL	@Pin= 20dBmx	dB	7.0	8.0	—
Gain Flatness	ΔG		dB	—	—	±0.8
3rd Order Intermodulation Distortion	IM3	Two-tone Test Po= 37.0dBm (Single Carrier Level) Δf= 5MHz (IM3) Δf= 150MHz (IM3-2)	dBc	-25	-27	—
	IM3-2		dBc	-25	-27	—
Drain Current	IDS2		A	—	1.75	2.25
Channel Temperature Rise	ΔTch	(VDS × IDS + Pin – Pout) × Rth(c-c)	°C	—	110	140

Recommended Gate Resistance(Rg): 13.3 Ω

ELECTRICAL CHARACTERISTICS (Ta= 25°C)

CHARACTERISTICS	SYMBOL	CONDITIONS	UNIT	MIN.	TYP.	MAX.
Transconductance	gm	VDS= 5V IDS= 2.5A	S	—	2.25	—
Pinch-off Voltage	VGSoff	VDS= 5V IDS= 11.5mA	V	-1.0	-4.0	-6.0
Saturated Drain Current	IDSS	VDS= 5V VGS= 0V	A	—	9.0	—
Gate-Source Breakdown Voltage	VGSO	IGS= -5mA	V	-10	—	—
Thermal Resistance	Rth(c-c)	Channel to Case	°C/W	—	2.8	3.2

◆ The information contained herein is presented as guidance for product use. No responsibility is assumed by Toshiba Infrastructure Systems & Solutions Corporation (hereinafter, referred to as “TISS”) for any infringement of patents or any other intellectual property rights of third parties that may result from the use of product. No license to any intellectual property right is granted by this document. The information contained herein is subject to change without prior notice. It is advisable to contact TISS before proceeding with design of equipment incorporating this product.

ABSOLUTE MAXIMUM RATINGS (Ta= 25°C)

CHARACTERISTICS	SYMBOL	UNIT	RATING
Drain-Source Voltage	VDS	V	50
Gate-Source Voltage	VGS	V	-10
Drain Current	IDS	A	7.5
Total Power Dissipation (Tc= 25°C)	PT	W	70
Channel Temperature	Tch	°C	250
Storage Temperature	Tstg	°C	-65 to +175

PACKAGE OUTLINE (7-AA07A)

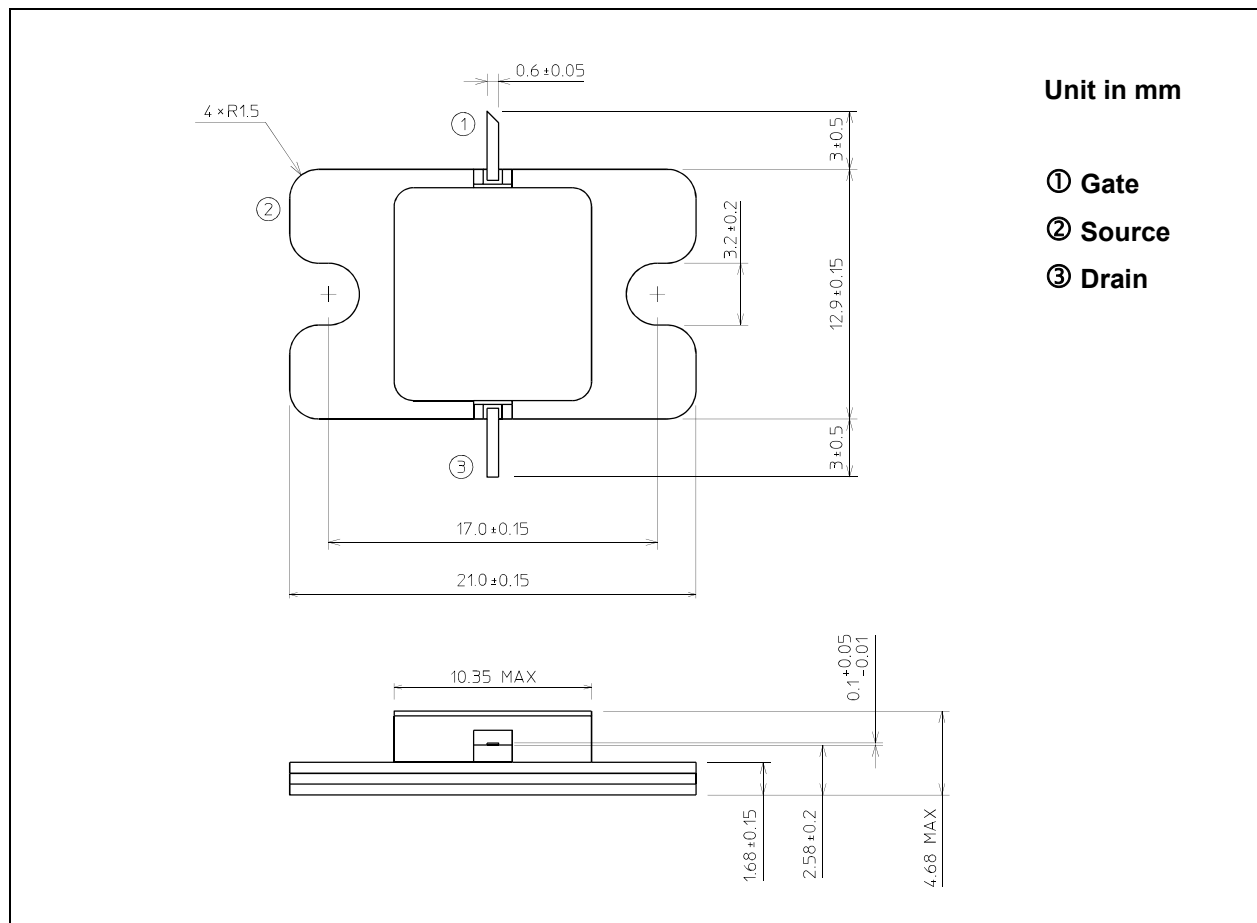

HANDLING PRECAUTIONS FOR PACKAGE MODEL

Soldering iron should be grounded and the operating time should not exceed 10 seconds at 260°C or 3 seconds at 350°C.

•Pout , Gain , PAE , IDS vs. Pin

VDS= 24 V, IDSset= 1.0 A, f= 12.7, 12.95, 13.2GHz, Ta= +25 °C

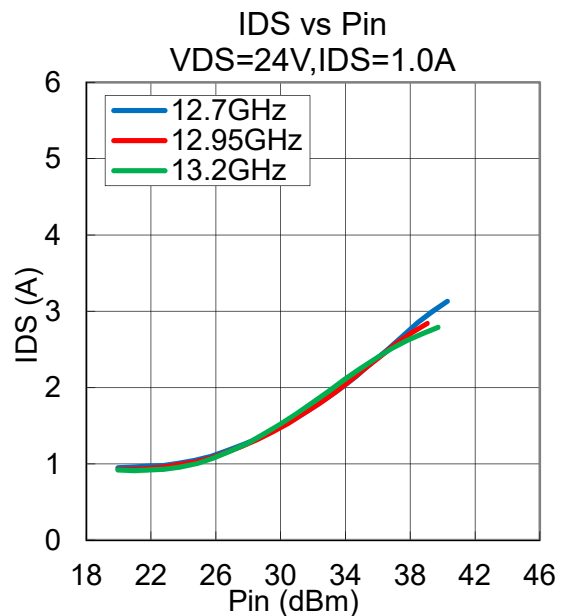
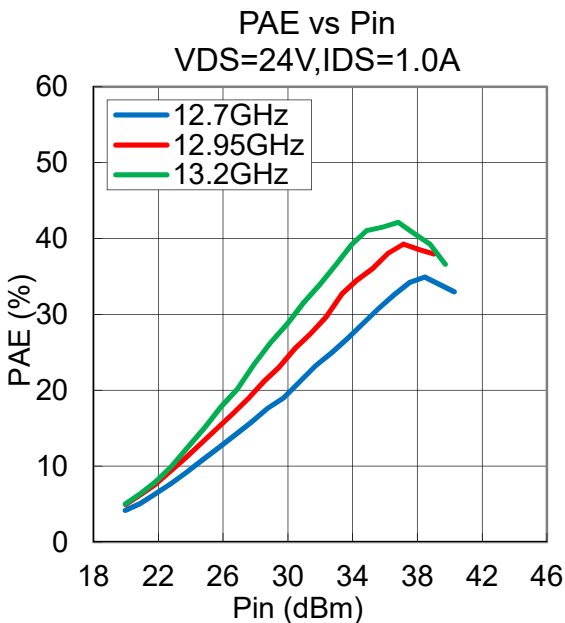
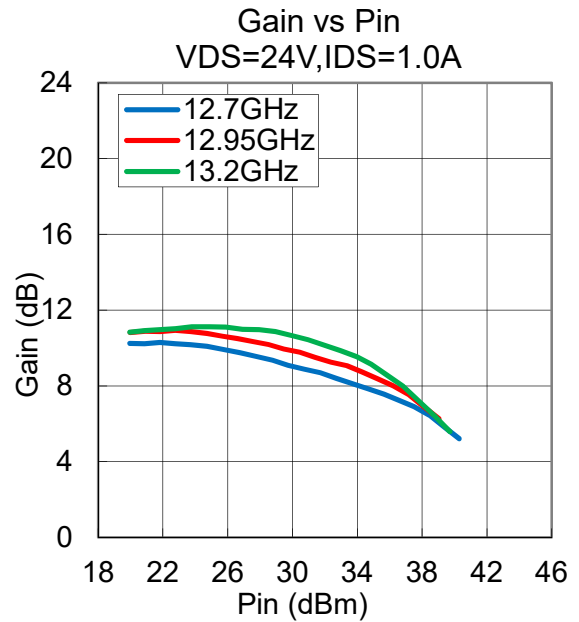
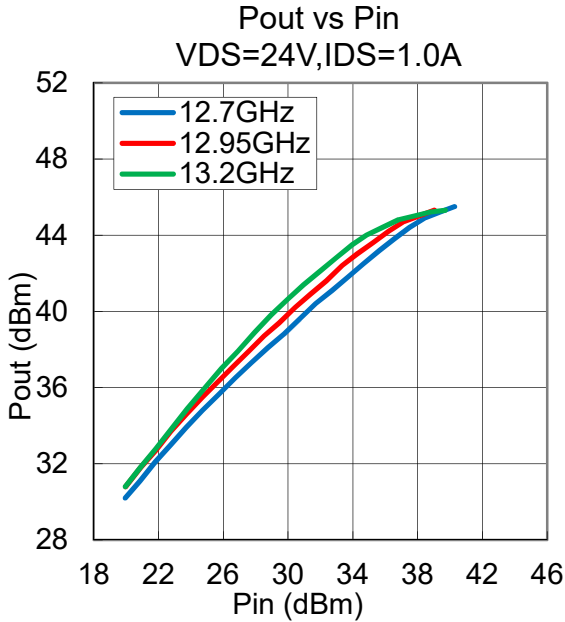

•IM3, IM5 vs. Pout

VDS= 24 V, IDSset= 1.0 A, f= 12.7, 12.95, 13.2 GHz, Δf= 5 MHz , Ta= +25 °C

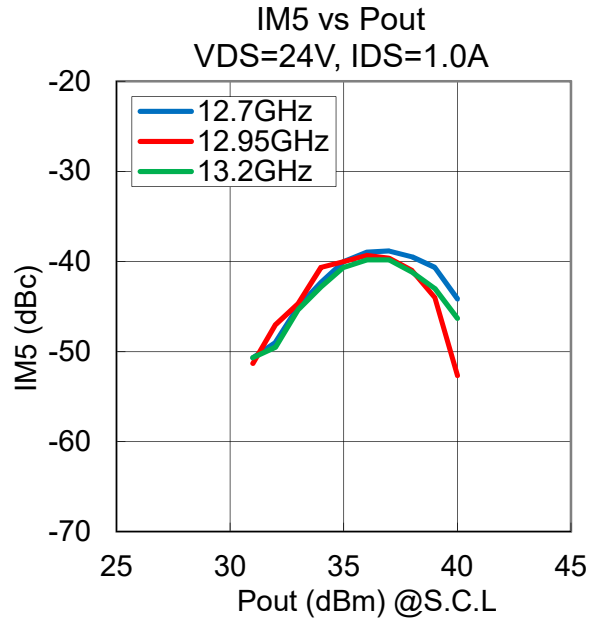
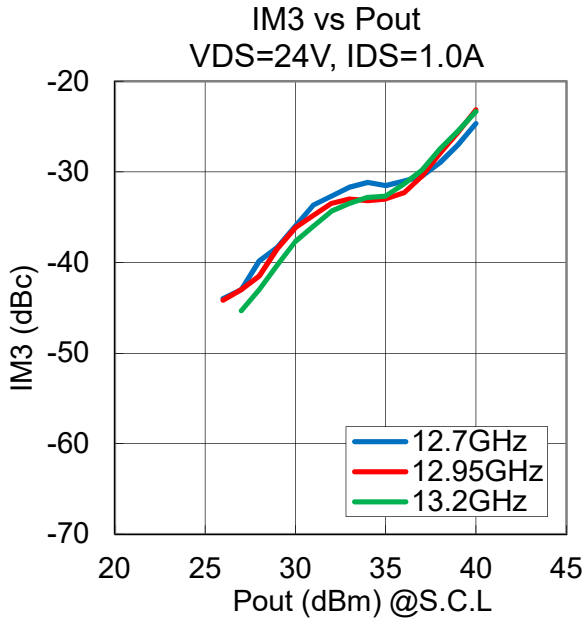

•IM3-2, IM5-2 vs. Pout

VDS= 24 V, IDSset= 1.0 A, f= 12.7, 12.95, 13.2 GHz, Δf= 150 MHz , Ta= +25 °C

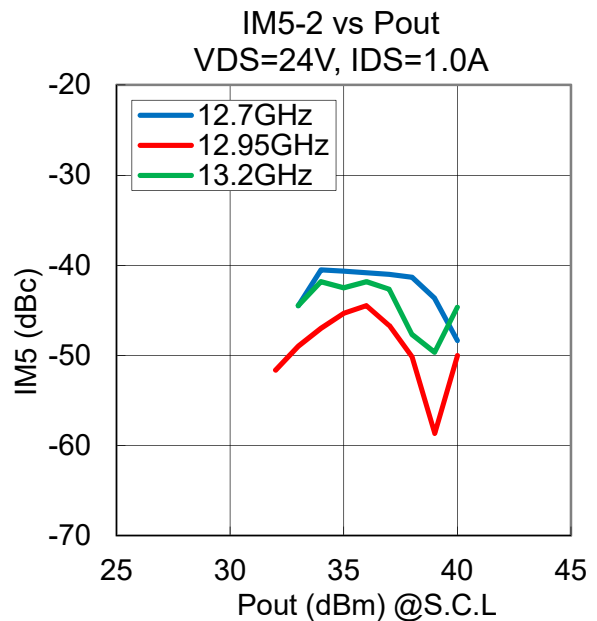
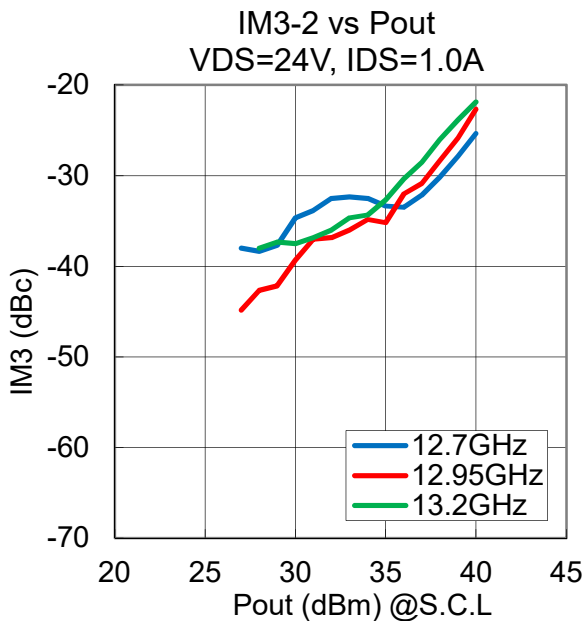

-Pout vs. Frequency

VDS= 24 V, IDSset= 1.0 A, Ta= +25 °C

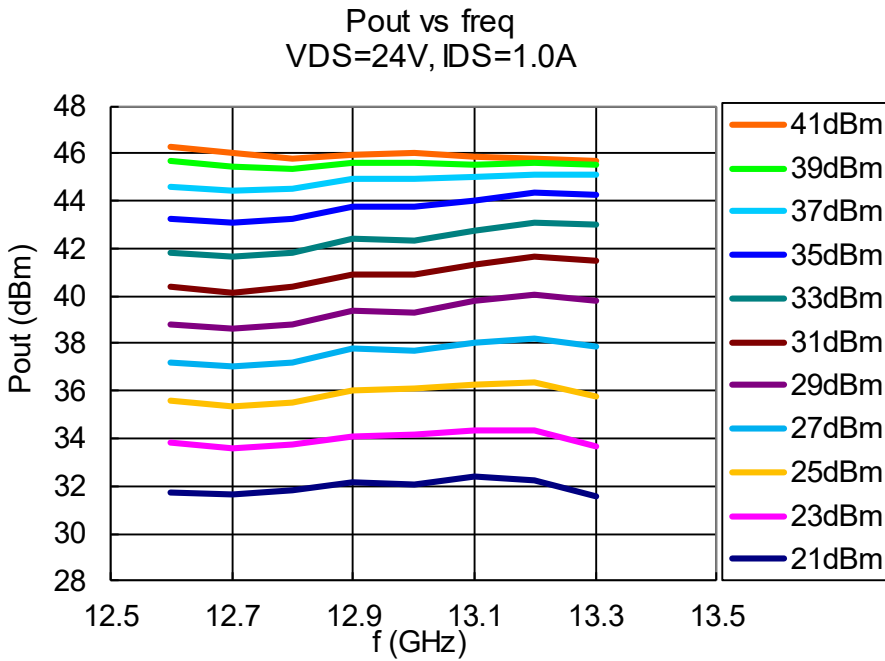

-IM3 vs. Δf (Two tone spacing)

VDS= 24V, IDSset= 1.0A, f= 12.95GHz, Po= 37dBmSCL, Ta= +25°C

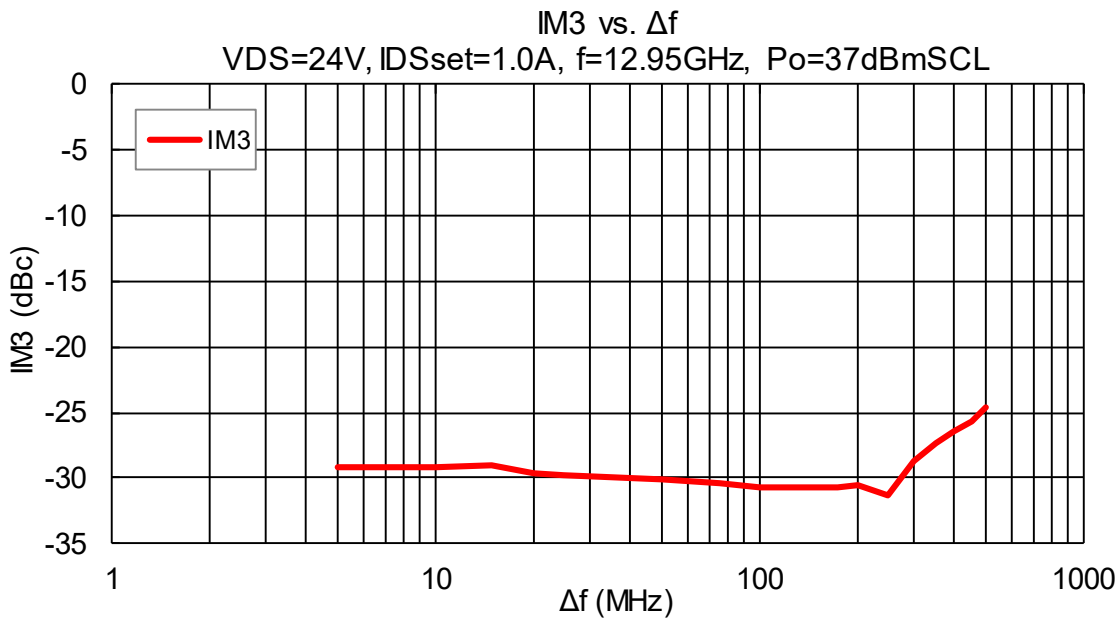

•Pout , Gain , PAE , IDS vs. Pin vs. IDSset

VDS= 24 V, IDSset= 0.5, 1.0, 1.5 A, f= 12.95 GHz, Ta= +25 °C

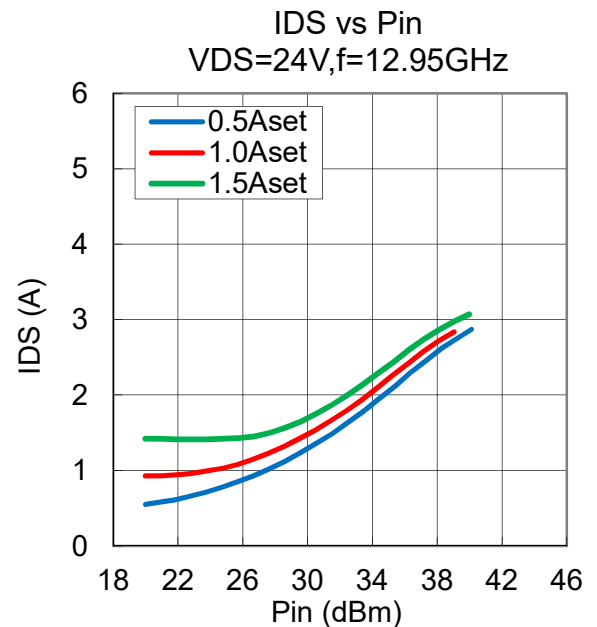
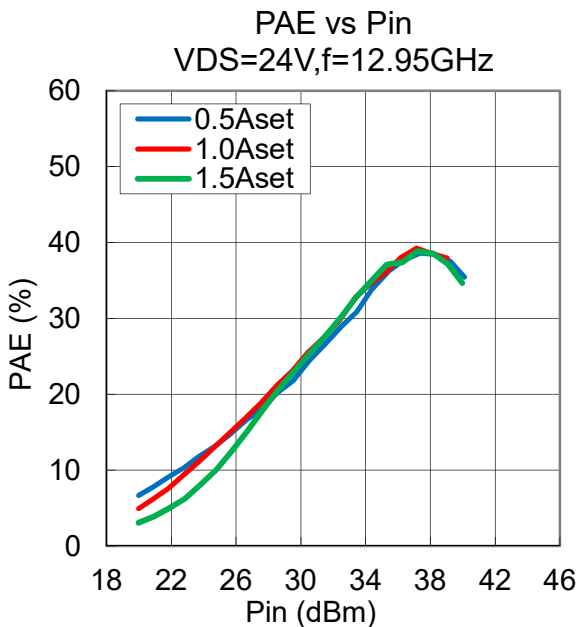
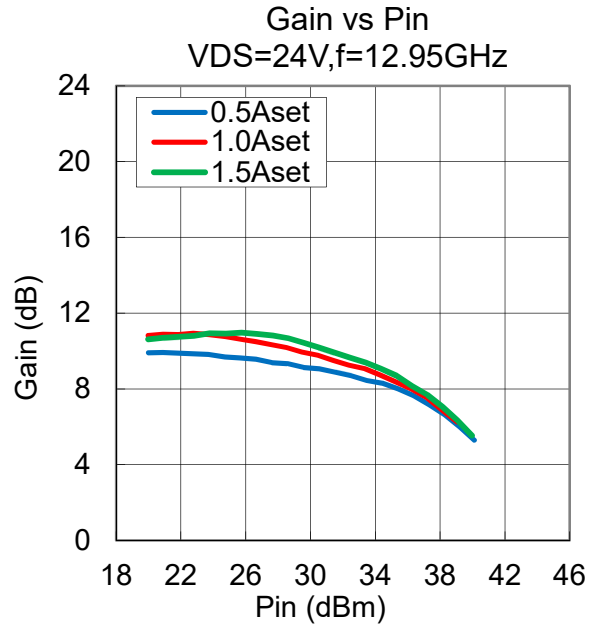
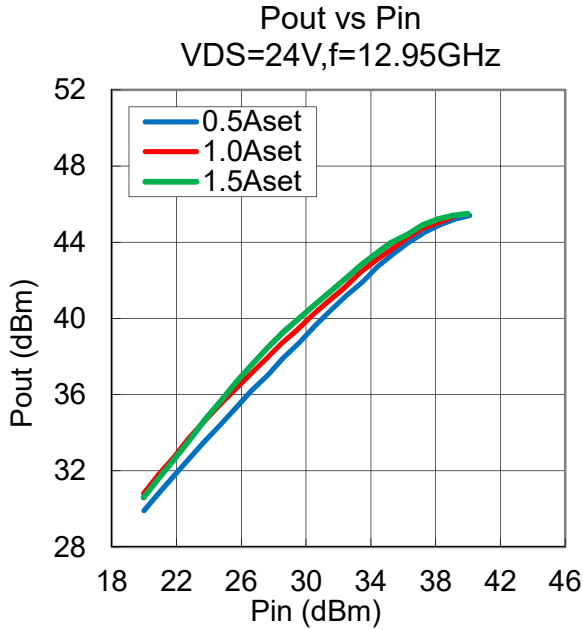

·Pout , Gain , PAE , IDS vs. Pin vs. Temperature

VDS= 24 V, IDSset= 1.0 A, f= 12.95 GHz, Ta= -25, +25, +75 °C

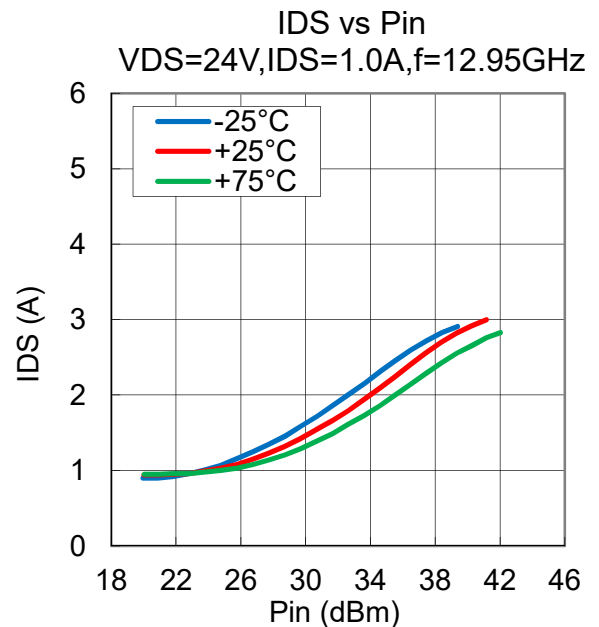
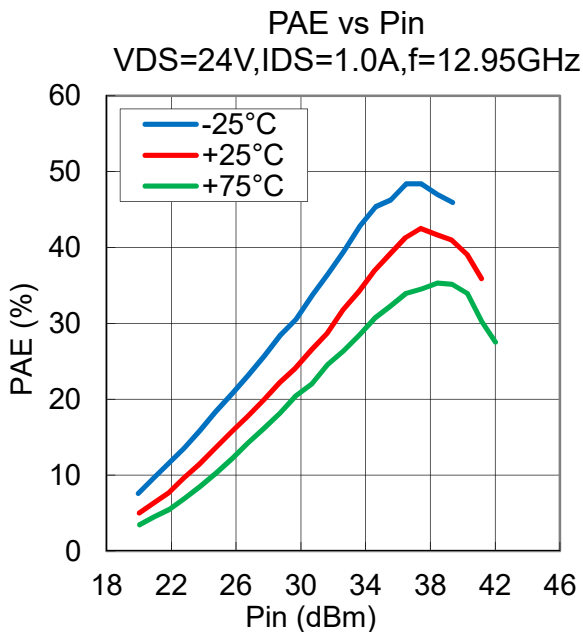
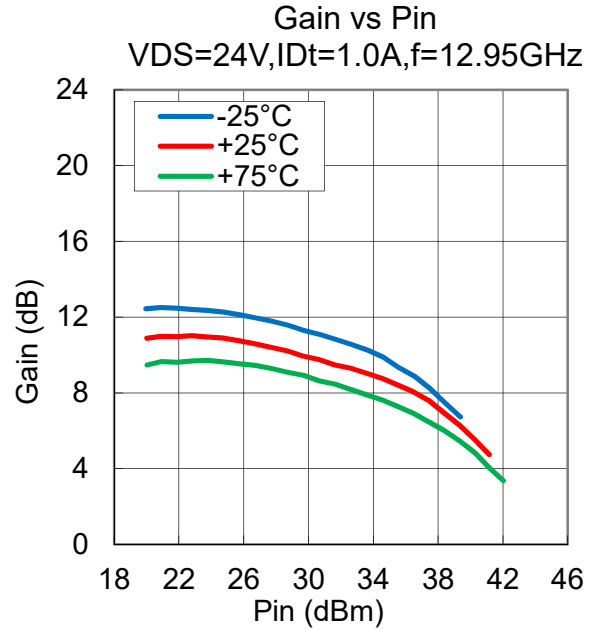
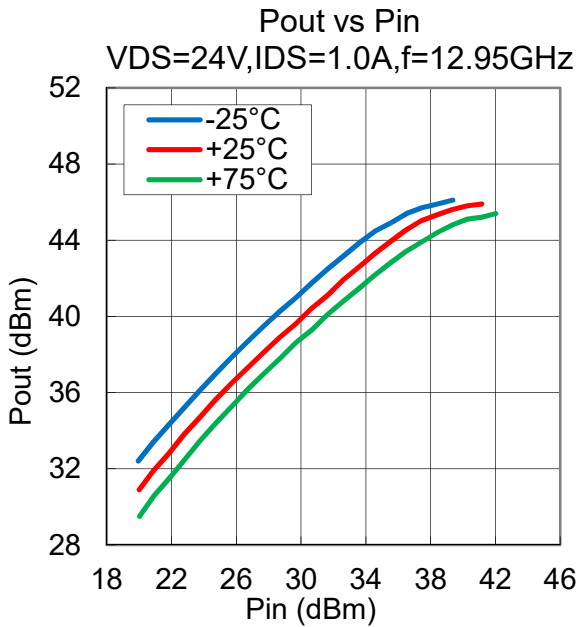

-S-Parameters

VDS= 24 V, IDSset= 1.0 A, f= 10.0 to 15.0 GHz, Ta= +25 °C

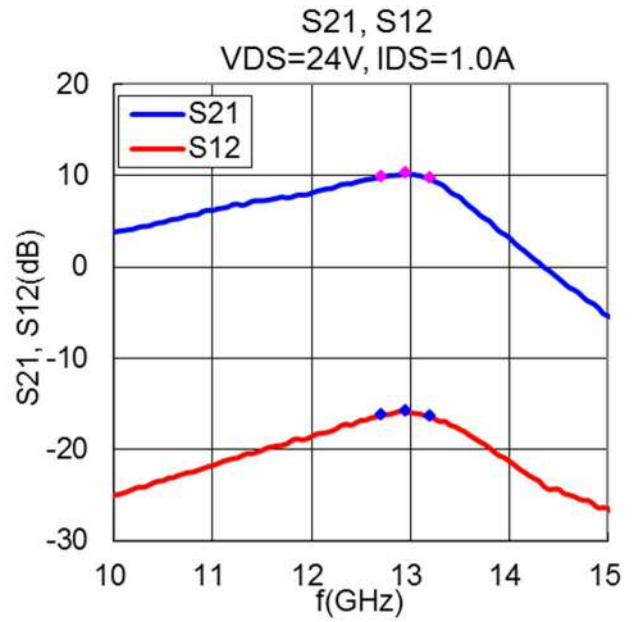
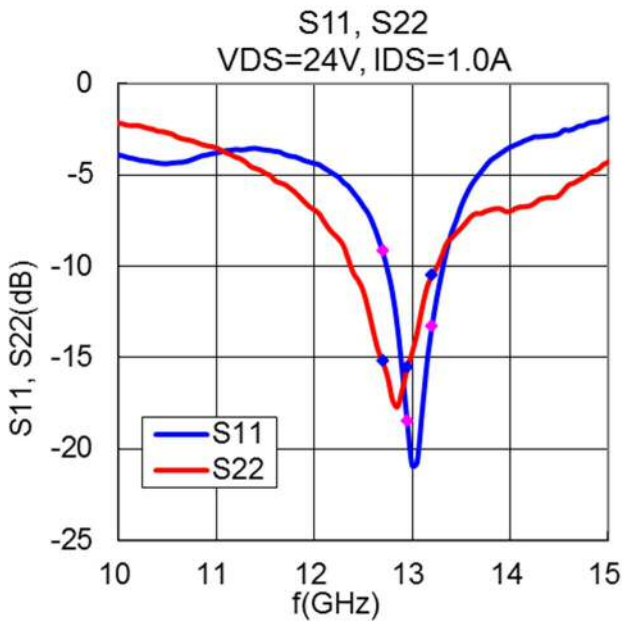
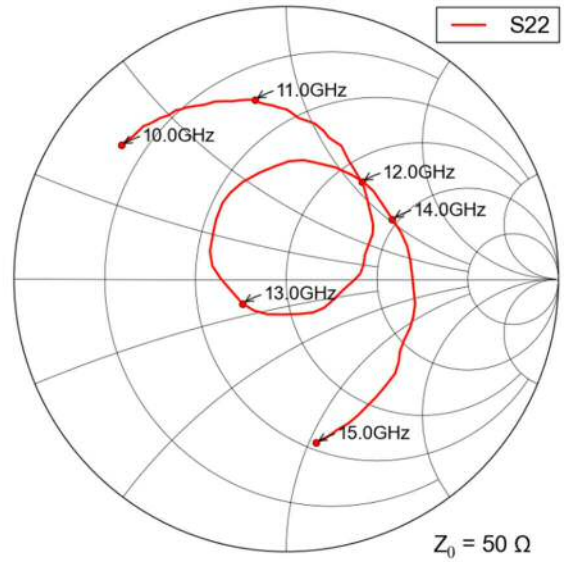
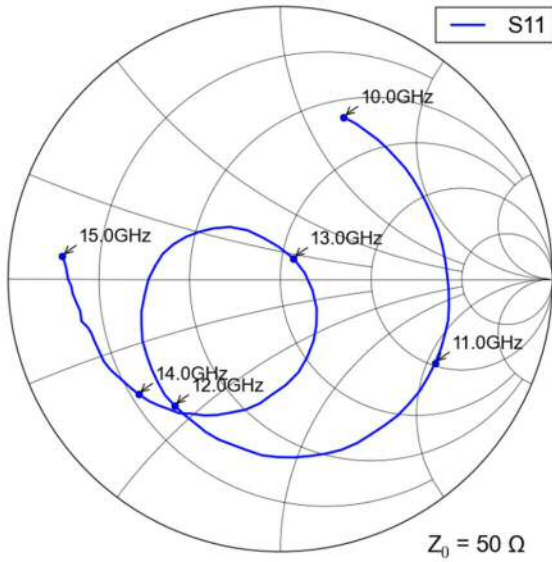

RESTRICTIONS ON PRODUCT USE

- All presented data are typical curves/values and for reference only as design guidance. Devices are not necessarily guaranteed at these curves and values.
- TISS, and its subsidiaries and affiliates (collectively "TOSHIBA"), reserve the right to make changes to the information in this document, and related hardware, software and systems (collectively "Product") without notice.
- This document and any information herein may not be reproduced without prior written permission from TOSHIBA. Even with TOSHIBA's written permission, reproduction is permissible only if reproduction is without alteration/omission.
- Though TOSHIBA works continually to improve Product's quality and reliability, Product can malfunction or fail. Customers are responsible for complying with safety standards and for providing adequate designs and safeguards for their hardware, software and systems which minimize risk and avoid situations in which a malfunction or failure of Product could cause loss of human life, bodily injury or damage to property, including data loss or corruption. Before creating and producing designs and using, customers must also refer to and comply with (a) the latest versions of all relevant TOSHIBA information, including without limitation, this document, the specifications, the data sheets and application notes for Product and the precautions and conditions set forth therein and (b) the instructions for the application that Product will be used with or for. Customers are solely responsible for all aspects of their own product design or applications, including but not limited to (a) determining the appropriateness of the use of this Product in such design or applications; (b) evaluating and determining the applicability of any information contained in this document, or in charts, diagrams, programs, algorithms, sample application circuits, or any other referenced documents; and (c) validating all operating parameters for such designs and applications. TOSHIBA ASSUMES NO LIABILITY FOR CUSTOMERS' PRODUCT DESIGN OR APPLICATIONS.
- Product is intended for use in communications equipment (including Rader) on the ground Product is neither Intended nor warranted for use in equipment or systems that require extraordinarily high levels of quality and/or reliability, and/or a malfunction or failure of which may cause loss of human life, bodily injury, serious property damage or serious public impact ("Unintended Use"). Unintended Use includes, without limitation, equipment used in nuclear facilities, equipment used in the aircraft and space equipment, medical equipment, equipment used for automobiles, trains, ships and other transportation, traffic signaling equipment, equipment used to control combustion or explosions, safety devises, elevators and escalators, devices related to electric power, and equipment used in finance-related fields. If you are considering using the Product in such situation, please contact us in advance.
- Do not disassemble, analyze, reverse-engineer, alter, modify, translate or copy Product, whether in whole or in part.
- Product shell not be used for or incorporated into any products or systems whose manufacture, use, or sale is prohibited under any applicable laws or regulations.
- The information contained herein is presented only as guidance for Product use. No responsibility is assumed by TOSHIBA for any infringement of patents or any other intellectual property rights of third parties that may result from the use of Product. No license to any intellectual property right is granted by this document, whether express or implied, by estoppel or otherwise.